

# LARYVOX® INSERTER UNIEK PRO

REF 25930



- ▶ **LARYVOX® INSERTER UNIEK PRO** se compone de un instrumento de colocación y de un aplicador. Permite la óptima colocación anterógrada o la sustitución de una válvula fonatoria **LARYVOX® UNIEK**.
- ▶ El instrumento de colocación dispone de una opción de fijación para colocar la prótesis fonatoria de forma segura.
- ▶ El aplicador permite una inserción fácil de la prótesis fonatoria y está preparado en pocos pasos.
- ▶ Además, la punta redondeada del aplicador facilita la colocación suave y proporciona máxima comodidad a la hora de sustituir la prótesis fonatoria.

## VOLUMEN DE SUMINISTRO

### LARYVOX® INSERTER UNIEK PRO REF 25930

- 1 x instrumento de colocación (blanco)
- 1 x aplicador
- 1 x adaptador
- 1 x lubricante
- 1 x Instrucciones de uso

Este insertador se utiliza exclusivamente en combinación con **LARYVOX® UNIEK**.

La prótesis fonatoria no está incluida en el volumen de suministro y se debe encargar por separado. Observe las instrucciones de uso de la prótesis fonatoria.

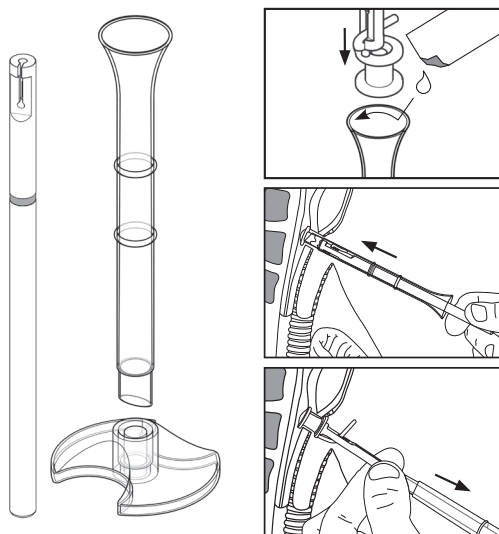

Producto

LARYVOX® INSERTER UNIEK PRO

PU

1 unidad

REF























25930

























# LARYVOX® INSERTER

## ASIGNACIÓN

25900	25910	25915	25920	25925 25930
LARYVOX® INSERTER	LARYVOX® INSERTER EXPERT	LARYVOX® INSERTER EXPERT SMALL	LARYVOX® INSERTER SPECIAL	LARYVOX® INSERTER UNIEK
Farbe				
				
				

Preste previamente atención a la longitud (xx) de la prótesis fonatoria que se va a insertar.

REF	Denominación prótesis vocal	Longitud	INSERTER
20 FRENCH			
AD20xx-NS	ADVANTAGE Indwelling 20 Fr. Voice Prosthesis	06-14 mm	
AD2004-NS	ADVANTAGE Indwelling 20 Fr. Voice Prosthesis	04 mm	
AS20xx-NS	ADVANTAGE Indwelling 20 Fr. Voice Prosthesis	06-14 mm	
AS2004-NS	ADVANTAGE Indwelling 20 Fr. Voice Prosthesis	04 mm	
DV20xx-LF	DUAL VALVE Indwelling LF 20 Fr. Voice Prosthesis	06-14 mm	
DV20xx-NS	DUAL VALVE Indwelling 20 Fr. Voice Prosthesis	06-14 mm	
IN2004-NS	CLASSIC Indwelling 4 mm 20 Fr. Voice Prosthesis	04 mm	
IN20xx-NS	CLASSIC Indwelling 20 Fr. Voice Prosthesis	06-20 mm	
IN2004-LEF	CLASSIC Indwelling LEF 4 mm 20 Fr. Voice Prosthesis	04 mm	
IN20xx-LEF	CLASSIC Indwelling LEF 20 Fr. Voice Prosthesis	06-14 mm	
IN20xx-IR	CLASSIC Indwelling IR 20 Fr. Voice Prosthesis	06-12 mm	
IN2004-LEIR	CLASSIC Indwelling LEIR 20 Fr. 4 mm Voice Prosthesis	04 mm	
IN20xx-LEIR	CLASSIC Indwelling LEIR 20 Fr. Voice Prosthesis	06-08 mm	
IN20xx-LESL	CLASSIC Indwelling LESL 20 Fr. Voice Prosthesis	05 und 07 mm	
IN2004-LETO	TEP Occluder Indw. LETO 20 Fr. 4 mm Voice Prosthesis	04 mm	
IN20xx-LETO	TEP Occluder Indw. LETO 20 Fr. Voice Prosthesis	06-14 mm	
IN2004-LF	CLASSIC Indwelling LF 20 Fr. 4 mm Voice Prosthesis	04 mm	
IN20xx-LF	CLASSIC Indwelling LF 20 Fr. Voice Prosthesis	06-14 mm	
IN20xx-SL	CLASSIC Indwelling SL 20 Fr. Voice Prosthesis	05,07 und 09 mm	
IN20xx-SO	CLASSIC Indwelling STERIL 20 Fr. Voice Prosthesis	08-14 mm	
25010-xx	LARYVOX® Uniek U.L.R. 21 Fr.	05-13 mm	
25020-xx	LARYVOX® Uniek U.L.R. 24 Fr.	05-13 mm	

REF	Denominación prótesis vocal	Longitud	INSERTER
16 FRENCH			
AS1604-NS	ADVANTAGE Indwelling 16 Fr. Voice Prosthesis	04 mm	
AS16xx-NS	ADVANTAGE Indwelling 16 Fr. Voice Prosthesis	06-14 mm	
IN1604-NS	CLASSIC Indwelling 4 mm 16 Fr. Voice Prosthesis	04 mm	
IN16xx-NS	CLASSIC Indwelling 6 mm 16 Fr. Voice Prosthesis	06-20 mm	
IN16xx-SO	CLASSIC Indwelling STERIL 10 mm 16 Fr. Voice Prosthesis	08-14 mm	
IN16xx-IR	CLASSIC Indwelling IR 16 Fr. Voice Prosthesis	06-12 mm	
IN1604-LEF	CLASSIC Indwelling LEF 4 mm 16 Fr. Voice Prosthesis	04 mm	
IN16xx-LEF	CLASSIC Indwelling LEF 16 Fr. Voice Prosthesis	06-14 mm	
IN16xx-LESL	CLASSIC Indwelling LESL 16 Fr. Voice Prosthesis	05 und 07 mm	
IN1604-LETO	CLASSIC Indwelling LETO 4 mm 16 Fr. Voice Prosthesis	04 mm	
IN16xx-LETO	CLASSIC Indwelling LETO 16 Fr. Voice Prosthesis	06-14 mm	
IN1604-LF	CLASSIC Indwelling LF 4 mm 16 Fr. Voice Prosthesis	04 mm	
IN16xx-LF	CLASSIC Indwelling LF 16 Fr. Voice Prosthesis	06-14 mm	
IN16xx-SL	CLASSIC Indwelling SL 16 Fr. Voice Prosthesis	05,07 und 09 mm	
IN16xx-SO	CLASSIC Indwelling STERIL 16 Fr. Voice Prosthesis	08-14 mm	
Impiego con la tecnica della capsula in gel			
IN20xx-NS	CLASSIC Indwelling 20 Fr. Voice Prosthesis	06-20 mm	
AD20xx-NS	ADVANTAGE Indwelling 20 Fr. Voice Prosthesis	06-14 mm	
AS20xx-NS	ADVANTAGE Indwelling 20 Fr. Voice Prosthesis	06-14 mm	
IN20xx-LF	CLASSIC Indwelling LF 20 Fr. Voice Prosthesis	06-14 mm	
IN20xx-LEF	CLASSIC Indwelling LEF 20 Fr. Voice Prosthesis	06-14 mm	
IN20xx-SL	CLASSIC Indwelling SL 20 Fr. Voice Prosthesis	05,07 und 09 mm	
IN20xx-LEIR	CLASSIC Indwelling LEIR 20 Fr. Voice Prosthesis	05 und 07 mm	
IN20xx-LESL	CLASSIC Indwelling LESL 20 Fr. Voice Prosthesis	05 und 07 mm	
IN20xx-IR	CLASSIC Indwelling IR 20 Fr. Voice Prosthesis	06-12 mm	
IN20xx-LETO	TEP Occluder Indw. LETO 20 Fr. Voice Prosthesis	06-14 mm	



Andreas Fahl Medizintechnik-Vertrieb GmbH es distribuidor exclusivo de productos Blom-Singer® en países seleccionados de Europa. Blom-Singer® es una marca registrada de Freudenberg Medical, LLC.